

## MULTISPLIT DC INVERTER RESIDENTIAL LINE R32 split system air conditioners



MULTISPLIT TREDI DC INVERTER



MULTISPLIT CEILING/FLOOR DC INVERTER



MULTISPLIT CONSOLE DC INVERTER



MULTISPLIT CASSETTE DC INVERTER

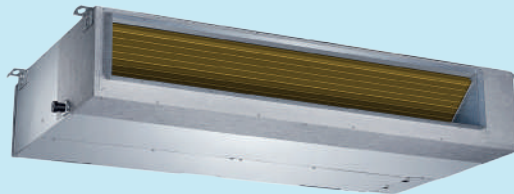

DC INVERTER DUCTED MULTISPLIT

### FUNCTIONALITY AND SAVINGS

The multi systems house a rotary compressor with DC Inverter technology. The Inverter is the most cutting edge of electronic technology applied to air conditioning today.

Running your air conditioner at variable speed and power ensures that the set temperature is reached quickly (about 2/3 of the time of a traditional air conditioner) and allows a reduction of up to 70% in energy consumption.

A2B Accorroni E.G. however, it also wanted to think about your health, equipping your wall-mounted split air conditioners with a plasma filter, activated carbon filter, bag filter and double electrostatic filter.

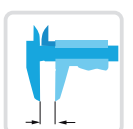
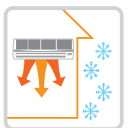
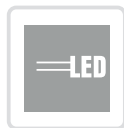
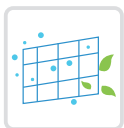

# MULTISPLIT DC INVERTER RESIDENTIAL LINE R32

## split system air conditioners

SCOP = 5,2 A+++



### TECHNICAL FEATURES

- Rotary compressor with DC Inverter technology.
- Quickness in reaching the set temperature (about 2/3 of the time of a traditional air conditioner)
- Up to 70% reduction in energy consumption.
- Silent operation
- Operation in heat pump up to -15 °C outside
- Automatic restart in case of power surges

### MULTI SPLIT OUTDOOR UNITS DC INVERTER

MODEL		REFRIGERATION POWER kW	THERMAL POWER kW	€
MULTI 2 LIGHT DC INVERTER OUTDOOR UNIT	cod. 64000002L	4,10 (2,28÷5,71)	4,39 (1,52÷4,98)	1.428,00
MULTI 2 DC INVERTER OUTDOOR UNIT	cod. 64000002	5,27 (2,28÷5,71)	5,56 (2,40÷5,74)	1.639,00
MULTI 3 LIGHT DC INVERTER OUTDOOR UNIT	cod. 64000003L	6,15 (1,99÷6,59)	6,44 (1,44÷6,68)	2.239,00
MULTI 3 DC INVERTER UNITÀ ESTERNA	cod. 64000003	7,91 (3,17÷8,20)	8,20 (2,28÷8,49)	2.559,00
MULTI 4 LIGHT DC INVERTER OUTDOOR UNIT	cod. 64000004L	8,20 (2,05÷9,84)	8,79 (2,34÷10,54)	3.060,00
MULTI 4 DC INVERTER OUTDOOR UNIT	cod. 64000004	10,54 (2,05÷12,65)	10,84 (2,34÷13,0)	3.464,00
MULTI 5 DC INVERTER OUTDOOR UNIT	cod. 63000005	12,30 (3,01÷12,30)	12,30 (3,45÷12,30)	4.952,00

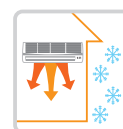
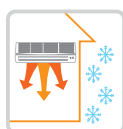

# MULTISPLIT DC INVERTER RESIDENTIAL LINE R32

## split system air conditioners

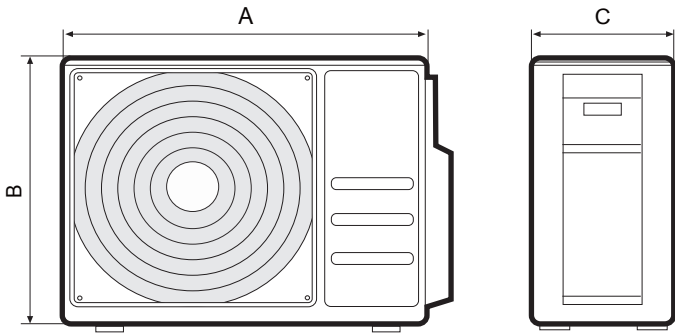

	A	B	C	
	mm	mm	mm	kg
MULTI 2 LIGHT INVERTER	800	554	333	31,6
MULTI 2 INVERTER	800	554	333	35,5
MULTI 3 LIGHT INVERTER	845	702	363	46,8
MULTI 3 INVERTER	845	702	363	51,1
MULTI 4 LIGHT INVERTER	946	810	410	62,1
MULTI 4 INVERTER	946	810	410	68,8
MULTI 5 INVERTER	946	810	410	73,3



TECHNICAL DATA TABLE	UM	MULTI 2 LIGHT	MULTI 2	MULTI 3 LIGHT	MULTI 3	MULTI 4 LIGHT	MULTI 4	MULTI 5
Refrigeration power	kW	4,10 (1,46÷4,98)	5,27 (2,28÷5,71)	6,15 (1,99÷6,59)	7,91 (3,17÷8,20)	8,20 (2,05÷9,84)	10,54 (2,05÷12,65)	12,30 (3,01÷12,30)
Absorbed power	kW	1,27 (0,11÷1,67)	1,63 (0,69÷2,00)	1,90 (0,18÷2,20)	2,45 (0,29÷3,10)	2,54 (0,89÷3,18)	3,27 (1,14÷4,09)	3,81 (0,28÷4,65)
Current consumption	A	5,80 (1,12÷7,35)	7,30 (3,2÷9,0)	8,30 (1,8÷10)	11,20 (2,0÷13,5)	11,30 (3,9÷14,1)	14,30 (5,1÷18,2)	16,00 (1,4÷20,7)
S.E.E.R		5,6 <b>A+</b>	6,1 <b>A++</b>	6,1 <b>A++</b>	6,1 <b>A++</b>	6,1 <b>A++</b>	6,2 <b>A++</b>	6,1 <b>A++</b>
Thermal power	kW	4,39 (1,52÷4,98)	5,56 (2,40÷5,74)	6,44 (1,44÷6,68)	8,20 (2,28÷8,49)	8,79 (2,34÷10,54)	10,84 (2,34÷13,00)	12,30 (3,45÷12,30)
Absorbed power	kW	1,18 (0,25÷1,59)	1,50 (0,60÷1,78)	1,73 (0,35÷1,80)	2,21 (0,37÷2,90)	2,20 (0,77÷2,75)	2,76 (0,97÷3,45)	3,30 (0,65÷3,80)
Current consumption	A	5,4 (1,9÷7,0)	6,6 (2,80÷7,95)	7,6 (2,6÷8)	10,1 (2,4÷13)	9,8 (3,4÷12,2)	12,1 (4,3÷15,3)	14,6 (3,0÷16,6)
S.C.O.P. Mid-range		3,8 <b>A</b>	3,8 <b>A+</b>	4,0 <b>A+</b>	4,0 <b>A+</b>	3,8 <b>A+</b>	3,8 <b>A+</b>	3,5 <b>A+</b>
S.C.O.P. Hot band		4,6 <b>A++</b>	5,1 <b>A+++</b>	4,8 <b>A++</b>	5,1 <b>A+++</b>	4,6 <b>A++</b>	5,2 <b>A+++</b>	5,1 <b>A+++</b>
Compressor		Rotary inverter	Rotary inverter	Rotary inverter	Rotary inverter	Rotary inverter	Rotary inverter	Rotary inverter
Power Supply		230/1/50Hz	230/1/50Hz	230/1/50Hz	230/1/50Hz	230/1/50Hz	230/1/50Hz	230/1/50Hz
Air flow	m <sup>3</sup> /h	2100	2100	3000	3000	3800	4000	3850
Sound level	dB(A)	65	65	65	68	67	67	69
External temperature*	°C	-15 / +50	-15 / +50	-15 / +50	-15 / +50	-15 / +50	-15 / +50	-15 / +50
Refrigerant quantity R32	g	1100	1250	1500	1850	2100	2100	2900
Piping length	m	≤ 25	≤ 25	≤ 30	≤ 30	≤ 35	≤ 35	≤ 35
Height difference between the I.U.	m	≤ 10	≤ 10	≤ 10	≤ 10	≤ 10	≤ 10	≤ 10
Gas attacks		2 x 3/8"	2 x 3/8"	2 x 3/8"	2 x 3/8"	3x3/8"+1x1/2"	3x3/8"+1x1/2"	4x3/8"+1x1/2"
Liquid attacks		2 x 1/4"	2 x 1/4"	2 x 1/4"	2 x 1/4"	4x1/4"	4x1/4"	5x1/4"

For system consumption, refer to the outdoor unit label

Cooling test conditions: int. 27 °C d.b. / 19.5 °C w.b. - ext. 35°C d.b. / 24°C w.b.

Heating test conditions: Int. 20 °C d.b. - Ext. 7 °C d.b. / 6 °C w.b.

## MULTISPLIT DC INVERTER - COMBINATIONS

### R32 split system air conditioners

MULTI 2 LIGHT	MULTI 3		MULTI 4		
9 + 9	9 + 9	9 + 9 + 9	9 + 9	9 + 9 + 9	12 + 12 + 18
9 + 12	9 + 12	9 + 9 + 12	9 + 12	9 + 9 + 12	9 + 9 + 9 + 9
MULTI 2	12 + 12	9 + 12 + 12	12 + 12	9 + 12 + 12	9 + 9 + 9 + 12
9 + 12	9 + 18	9 + 9 + 18	9 + 18	9 + 9 + 18	9 + 9 + 12 + 12
12 + 12	12 + 18	12 + 12 + 12	12 + 18	12 + 12 + 12	9 + 12 + 12 + 18
9 + 18			18 + 18	9 + 12 + 18	12 + 12 + 12 + 12
MULTI 3 LIGHT	MULTI 4 LIGHT				
9 + 9 + 9	9 + 9 + 12	9 + 9 + 9 + 9			
9 + 9 + 12	12 + 12 + 12	9 + 9 + 9 + 9 + 12			
		9 + 12 + 18			

MULTI 5			
9 + 9	9 + 9 + 9	9 + 9 + 9 + 9	9 + 9 + 9 + 9 + 9
9 + 12	9 + 9 + 12	9 + 9 + 9 + 12	9 + 9 + 9 + 9 + 12
9 + 18	9 + 9 + 18	9 + 9 + 9 + 18	9 + 9 + 9 + 9 + 18
9 + 24	9 + 9 + 24	9 + 9 + 9 + 24	9 + 9 + 9 + 9 + 24
12 + 12	9 + 12 + 12	9 + 9 + 12 + 12	9 + 9 + 9 + 12 + 12
12 + 18	9 + 12 + 18	9 + 9 + 12 + 18	9 + 9 + 9 + 12 + 18
12 + 24	9 + 12 + 24	9 + 9 + 12 + 24	9 + 9 + 9 + 12 + 24
18 + 18	9 + 18 + 18	9 + 9 + 18 + 18	9 + 9 + 9 + 18 + 18
18 + 24	9 + 18 + 24	9 + 9 + 18 + 24	9 + 9 + 12 + 12 + 12
24 + 24	9 + 24 + 24	9 + 12 + 12 + 12	9 + 9 + 12 + 18 + 18
	12 + 12 + 12	9 + 12 + 12 + 18	9 + 12 + 12 + 12 + 12
	12 + 12 + 18	9 + 12 + 12 + 24	9 + 12 + 12 + 12 + 18
	12 + 12 + 24	9 + 12 + 18 + 18	
	12 + 18 + 18	9 + 12 + 18 + 24	
	12 + 18 + 24	9 + 18 + 18 + 18	
	12 + 24 + 24	12 + 12 + 12 + 12	
	18 + 18 + 18	12 + 12 + 12 + 18	
	18 + 18 + 24	12 + 12 + 12 + 24	
		12 + 12 + 18 + 18	

# MULTISPLIT TREDI DC INVERTER - INDOOR UNIT

## R32 split system air conditioners - Wi-Fi as standard

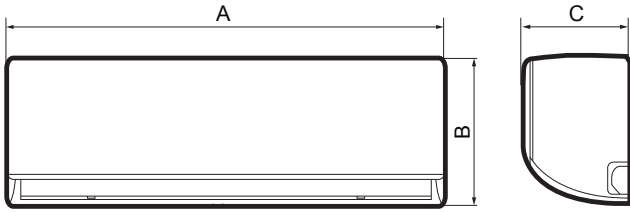

	A	B	C	
	mm	mm	mm	kg
TREDI 9 DC INVERTER UI	722	290	187	7,3
TREDI 12 DC INVERTER UI	802	297	189	8,6
TREDI 18 DC INVERTER UI	965	319	215	10,9
TREDI 24 DC INVERTER UI	1080	335	226	13,7

### TECHNICAL FEATURES

- Silent operation: 26 dB(A) at minimum speed
- Energy class A+++
- Exceptional cooling performance, excellent performance even with external temperatures down to -15 °C
- Sleep function
- The timer function allows you to program the air conditioner to turn on and off
- The Turbo button allows the set temperature to be reached much faster in cooling mode
- Follow Mee Wifi function as standard
- Standard Silver Ion filter
- Rotary compressor with DC Inverter technology
- Up to 70% reduction in energy consumption
- Operation in heat pump up to -15 °C outside
- Automatic restart in case of power surges

### MULTISPLIT TREDI DC INVERTER

MODEL	REFRIGERATION POWER kW	THERMAL POWER kW	€
MULTISPLIT TREDI 9 DC INVERTER I.U. R32 cod. 66440000R	2,64 (1,02÷3,19)	2,93 (0,82÷3,36)	338,00
MULTISPLIT TREDI 12 DC INVERTER I.U. R32 cod. 66430000R	3,52 (0,82÷4,16)	3,81 (1,08÷4,2)	396,00
MULTISPLIT TREDI 18 DC INVERTER I.U. R32 cod. 66490000R	5,28 (3,39÷5,89)	5,42 (3,10÷5,84)	528,00
MULTISPLIT TREDI 24 DC INVERTER I.U. R32 cod. 66520000R	6,72 (2,11÷8,20)	6,71 (1,55÷8,20)	643,00

TECHNICAL DATA	UM	MULTI TREDI 9	MULTI TREDI 12	MULTI TREDI 18	MULTI TREDI 24
Refrigeration power	kW	2,64 (1,02÷3,19)	3,52 (0,82÷4,16)	5,28 (3,39÷5,89)	6,27 (2,11÷8,20)
Absorbed power	W	24	24	34	62
Current consumption	A	0,11	0,11	0,15	0,28
Thermal power	kW	2,93 (0,82÷3,36)	3,81 (1,08÷4,2)	5,42 (3,10÷5,84)	6,71 (1,55÷8,20)
Absorbed power	W	24	24	34	62
Current consumption	A	0,11	0,11	0,15	0,28
Power Supply		230V/1/50Hz	230V/1/50Hz	230V/1/50Hz	230V/1/50Hz
Air flow	m³/h	416/309/230	584/477/395	730/500/420	1020/830/640
Sound level	dB(A)	39/32/36	39/32/36	43/33/28	47/41,5/30,5
Attacks Liquid		3/8"	3/8"	1/2"	5/8"
Gas attacks		1/4"	1/4"	1/4"	3/8"

Cooling test conditions: int. 27 °C d.b. / 19.5 °C w.b. - ext. 35°C d.b. / 24°C w.b.

Heating test conditions: Int. 20 °C d.b. - Ext. 7 °C d.b. / 6 °C w.b.

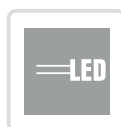
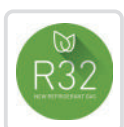

# MULTISPLIT CEILING/FLOOR DC INVERTER R32 split system air conditioners with Wi-Fi setup

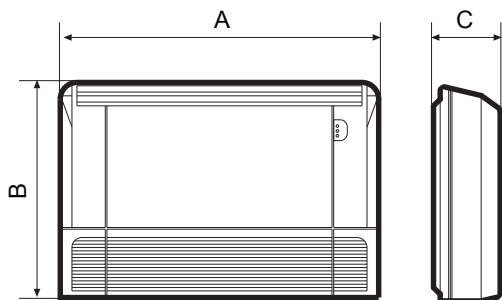

	A	B	C	
	mm	mm	mm	kg
CEILING/FLOOR 18 INVERTER U.I.	1068	675	235	28

## TECHNICAL FEATURES

- Equipped with remote control
- Rotary compressor with DC Inverter technology
- Quickness in reaching the set temperature (about 2/3 of the time of a traditional air conditioner)
- Up to 70% reduction in energy consumption and silent operation
- Automatic restart in case of power surges
- Possibility of ceiling or floor installation
- With WI-FI predisposition via Smart Port

## MULTISPLIT CEILING / FLOOR DC INVERTER

MODEL		REFRIGERATION POWER kW	THERMAL POWER kW	€
CEILING/FLOOR 18 DC INVERTER U.I.	cod. 64000011	5,27 (2,71÷5,86)	5,56 (2,42÷6,30)	1.135,00

## ACCESSORIES

	WI-FI SMART PORT WI-FI WALL CONTROL FOR CONSOLE, CEILING/FLOOR, CASSETTE AND DUCTED	cod. 63000012	164,00
--	---	---------------	--------

TECHNICAL DATA TABLE	UM	CEILING / FLOOR 18
Refrigeration power	kW	5,27 (2,71÷5,86)
Absorbed power	W	96
Current consumption	A	0,44
Thermal power	kW	5,56 (2,42÷6,30)
Absorbed power	W	96
Current consumption	A	0,44
Power Supply		230V/1/50Hz
Air flow	m <sup>3</sup> /h	958/839/723
Sound level	dB (A)	44/41/37
Gas attacks		1/2"
Attacks Liquid		1/4"

For system consumption, refer to the outdoor unit label

Cooling test conditions: int. 27 °C d.b. / 19.5 °C w.b. - ext. 35°C d.b. / 24°C w.b.

Heating test conditions: Int. 20 °C d.b. - Ext. 7 °C d.b. / 6 °C w.b.

# MULTISPLIT CONSOLE DC INVERTER

## Split system air conditioners

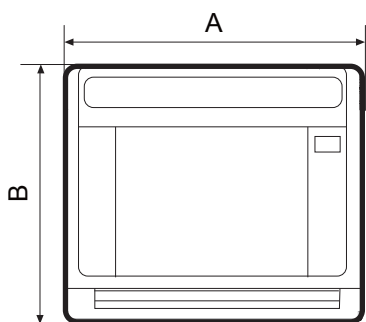

	A	B	C	
	mm	mm	mm	kg
CONSOLE 12 INVERTER U.I.	794	621	206	14,9

### TECHNICAL FEATURES

- Equipped with remote control
- Rotary compressor with DC Inverter technology
- Quickness in reaching the set temperature (about 2/3 of the time of a traditional air conditioner) with up to 70% reduction in energy consumption
- Silent operation
- Automatic restart in case of power surges
- With Wifi predisposition via Smart port and clean contact for optional remote On-Off

MODEL	POTENZA FRIGORIFERA	POTENZA TERMICA	€
	kW	kW	
CONSOLE 12 DC INVERTER U.I. <span style="float: right;">cod. 63000014</span>	3,52	3,81	924,00

TAB. DATI TECNICI	UM	CONSOLE 12
Refrigeration power	kW	3,52
Absorbed power	kW	1,0
Current consumption	A	4,52
S.E.E.R.		6,1 <b>A++</b>
Thermal power	kW	3,81
Absorbed power	kW	0,98
Current consumption	A	4,43
S.C.O.P. Mid-range		4,0 <b>A+</b>
S.C.O.P. Hot band		5,1 <b>A+++</b>
Power Supply		230V/1/50Hz
Air flow	m <sup>3</sup> /h	650/580/490
Sound level I.U.	dB (A)	37/34/27
Length Piping	m	≤ 25
Height difference between Units	m	≤ 10
Gas attacks		3/8"
Attacks Liquid		1/4"

\*Value referred to the sum of the external unit + internal unit absorptions (separate power supplies)  
 Cooling test conditions: int. 27 °C d.b. / 19.5 °C w.b. - ext. 35°C d.b. / 24°C w.b.  
 Heating test conditions: Int. 20 °C d.b. - Ext. 7 °C d.b. / 6 °C w.b.

# MULTISPLIT CASSETTA DC INVERTER R32

## split system air conditioners with Wi-Fi setup

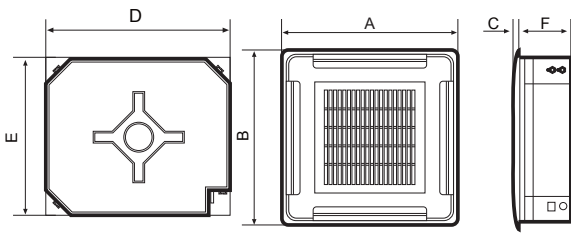

	A	B	C	D	E	F	
	mm	mm	mm	mm	mm	mm	kg
CASSETTA INVERTER 12 U.I.	647	647	50	570	570	260	18,8
CASSETTA INVERTER 18 U.I.	647	647	50	570	570	260	18,8



### TECHNICAL FEATURES

- Equipped with remote control and condensate drain pump
- Rotary compressor with DC Inverter technology
- Quickness in reaching the set temperature (about 2/3 of the time of a traditional air conditioner)
- Up to 70% reduction in energy consumption and silent operation
- Automatic restart in case of power surges
- Ideal installation for suspended ceilings
- WI-FI ready via Smart Port

### MULTISPLIT CASSETTA DC INVERTER

MODEL		REFRIGERATION POWER kW	THERMAL POWER kW	€
CASSETTA 12 DC INVERTER U.I. R32	cod. 64000006	3,51 (0,85÷4,11)	3,80 (0,47÷4,31)	1.065,00
CASSETTA 18 DC INVERTER U.I. R32	cod. 64000007	5,27 (2,90÷5,59)	5,23 (2,37÷6,10)	1.194,00

### ACCESSORI

	WI-FI SMART PORT WI-FI WALL CONTROL FOR CONSOLE, CEILING/FLOOR, CASSETTE AND DUCTED	cod. 63000012	164,00
--	---	---------------	--------

TECHNICAL DATA	UM	CASSETTA 12	CASSETTA 18
Refrigeration power	kW	3,51 (0,85÷4,11)	5,27 (2,90÷5,59)
Absorbed power	W	20	45
Current consumption	A	4,45	0,20
Thermal power	kW	3,80 (0,47÷4,31)	5,23 (2,37÷6,10)
Absorbed power	W	20	45
Current consumption	A	4,73	0,20
Power Supply		230V/1/50Hz	230V/1/50Hz
Air flow	m <sup>3</sup> /h	569/485/389	680/584/479
Sound level	dB (A)	42/37,5/34,5	45,4/44/39
Gas attacks		3/8"	1/2"
Attacks Liquid		1/4"	1/4"

For system consumption, refer to the outdoor unit label

Cooling test conditions: int. 27 °C d.b. / 19.5 °C w.b. - ext. 35°C d.b. / 24°C w.b.

Heating test conditions: Int. 20 °C d.b. - Ext. 7 °C d.b. / 6 °C w.b.



# DUCTED MULTISPLIT DC INVERTER R32

## split system air conditioners with Wi-Fi setup

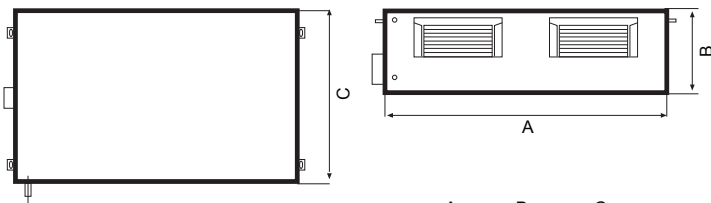

	A	B	C	
	mm	mm	mm	kg
DUCTABLE 9 INVERTER U.I.	700	200	450	18
DUCTABLE 12 INVERTER U.I.	700	200	506	18
DUCTABLE 18 INVERTER U.I.	880	210	674	24,3

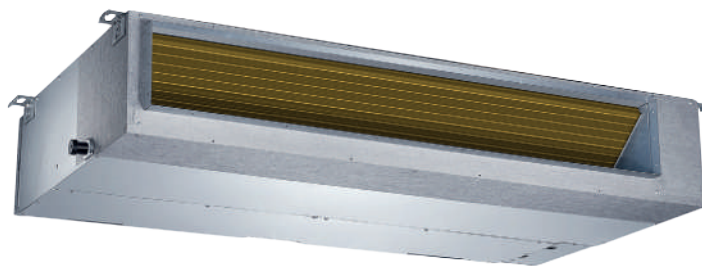

### TECHNICAL FEATURES

- Equipped with remote control and condensate drain pump up to 200 mm (except 9,000 Btu version)
- Rotary compressor with DC Inverter technology
- Quickness in reaching the set temperature (about 2/3 of the time of a traditional air conditioner)
- Up to 70% reduction in energy consumption and silent operation
- Automatic restart in case of power surges
- Ideal installation for suspended ceilings
- WI-FI ready via Smart Port

### DC INVERTER DUCTED MULTISPLIT

MODEL		REFRIGERATION POWER kW	THERMAL POWER kW	€
DUCTABLE 9 DC INVERTER U.I. R32	cod. 64000008	2,63	2,93	919,00
DUCTABLE 12 DC INVERTER U.I. R32	cod. 64000009	3,51	3,80	924,00
DUCTABLE 18 DC INVERTER U.I. R32	cod. 64000010	5,27	5,56	1.156,00

### ACCESSORI

	WI-FI SMART PORT WI-FI WALL CONTROL FOR CONSOLE, CEILING/FLOOR, CASSETTE AND DUCTED	cod. 63000012	164,00
--	---	---------------	--------

TECHNICAL DATA	UM	CANAL 9	CANAL 12	CANAL 18
Refrigeration power	kW	2,63	3,51	5,27
Absorbed power	W	180	185	200
Current consumption	A	1,1	1,1	1,3
Thermal power	kW	2,93	3,80	5,56
Absorbed power	W	180	185	200
Current consumption	A	1,1	1,1	1,3
Power Supply		230V/1/50Hz	230V/1/50Hz	230V/1/50Hz
Air flow	m <sup>3</sup> /h	500/340/230	600/480/300	911/706,3/515,2
Useful prevalence	Pa	0 - 40	0 - 60	0 - 100
Sound level	dB (A)	40/34,5/27,5	34,5/30,5/29/23	41/38/34/26
Gas attacks		3/8"	3/8"	1/2"
Attacks Liquid		1/4"	1/4"	1/4"

For system consumption, refer to the outdoor unit label

Cooling test conditions: int. 27 °C d.b. / 19.5 °C w.b. - ext. 35°C d.b. / 24°C w.b.

Heating test conditions: Int. 20 °C d.b. - Ext. 7 °C d.b. / 6 °C w.b.